



Tote Bag

Finished size: 14" x 5½" x 17" (35 x 14 x 43 cm)

SEWING SUPPLIES

7/8 yard of 55" (75 x 140cm) wide white cotton canvas fabric

Sewing thread to match the fabric

Grey 40 wt embroidery thread

Bobbin thread

Tear-away stabilizer

Scissors

HUSQVARNA VIKING® ACCESSORIES

HUSQVARNA VIKING® H | CLASS™ 500E Sewing and Embroidery Machine

INSPIRA® Embroidery Needle Size 75 6200716-96

Pictogram Pen 4120838-48

Fasturn set 4125508-01

CUT

White canvas:

One 22" x 24" (51.5 x 112 cm) for bag

Two 4" x 36" (10 x 90 cm) for handle

3/8" (1 cm) seam allowance included in all measurements

EMBROIDERY

The bag is decorated with a "shopping list" using some French words:

fromage, jus d'orange, baguette, croissant, pommes de terre

The words are programmed using your H | CLASS™ 500E Software. To create the words, follow the step by step instructions below.

Prepare your machine for embroidery and connect to your PC. For more information see your H | CLASS™ 500E Quick Start Guide or the User's Guide (page 41-42).

Insert an embroidery needle.

To ease the hooping and the placement of the embroidery, mark lines with the Pictogram Pen on the white 22" x 24" (51.5 x 112 cm) tote piece as illustrated.

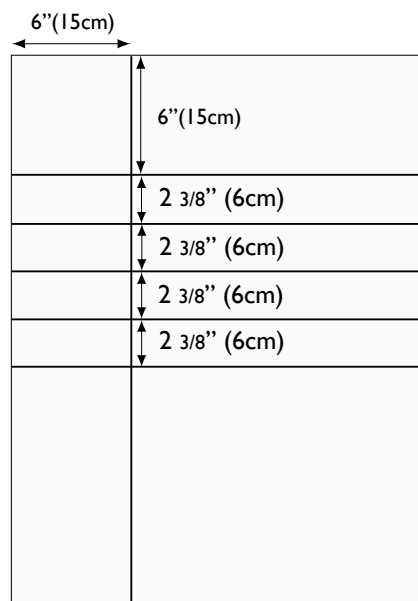

Create the Embroidery Design

Open your H | CLASS™ 500E Software.

1. Select hoop size (sample was made using the “large” hoop).

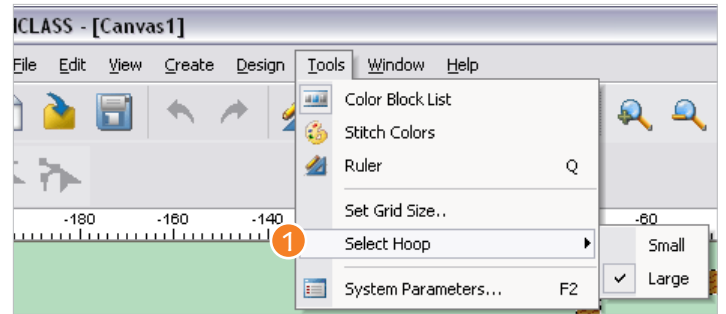

2. Click on “T” to activate the text function.

3. Choose a font (we used “Amazone”).

4. Select font height (we used “300”) and space (we used 5).

5. Type the first word, “fromage”.

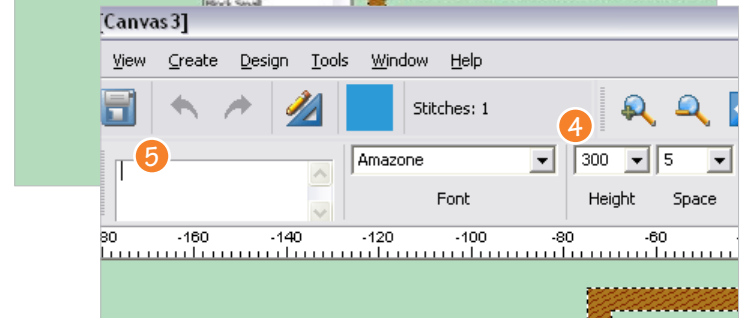
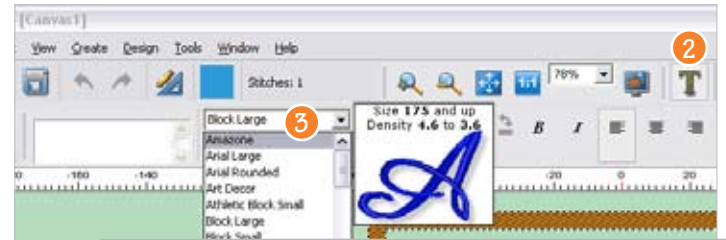

6. Click and drag one of the corners marked with a circle to rotate the design 90°.

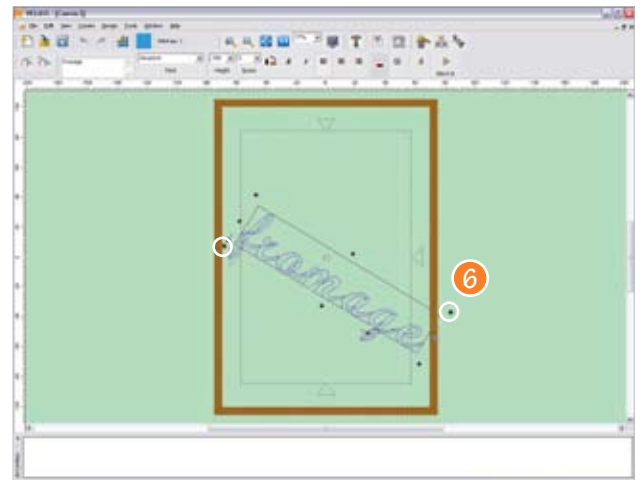

7. Position the embroidery in the top center of the hoop.

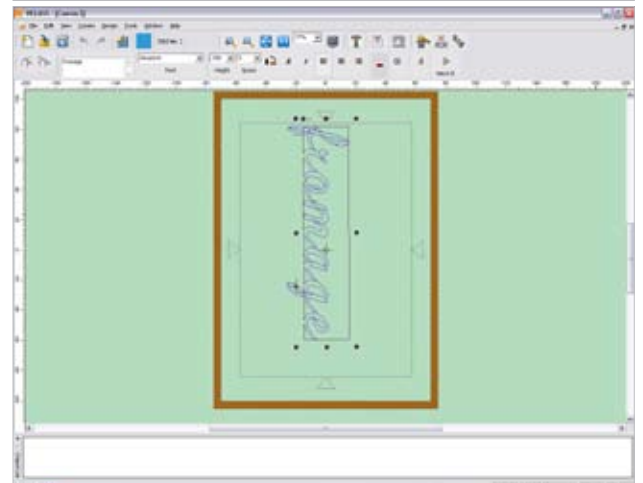

8 Click outside the selection to create an embroidery of the word.

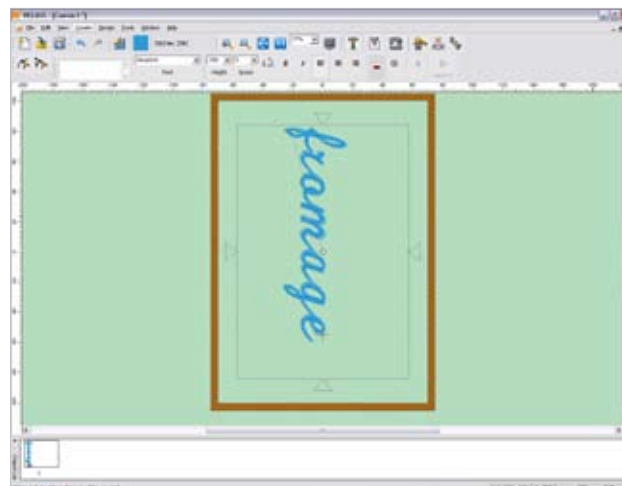

9. Click on the sewing machine icon to open a pop-up window with different send options. Click "Send design" to send the embroidery design to your machine.

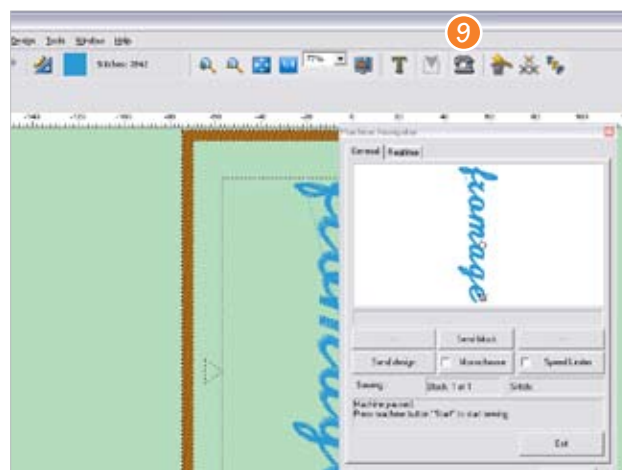

Prepare for Embroidery

(For detailed hooping instructions and instructions on how to attach the hoop to the embroidery unit see your **H | CLASS™ 500E Quick Start Guide** or the **User's Guide** (page 43-44)).

Place Tear-Away Stabilizer on top of the outer hoop. Position the tote bag piece on top.

Place the inner hoop centered on the first horizontal line. The vertical line should line up with the inner hoop as illustrated. Tighten the hoop screw.

Thread your machine with grey embroidery thread on top and embroidery bobbin thread in the bobbin.

Attach the hoop to the embroidery unit.

Embroider the first word!

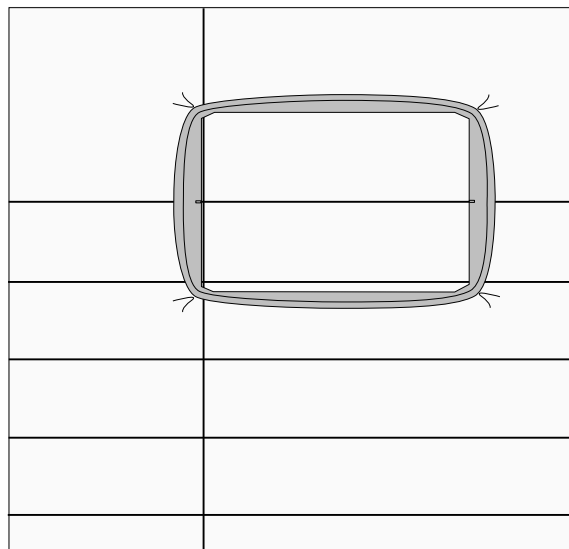

Embroider the Remaining Words

When finished, loosen the hoop screw and line up the center of the inner hoop with the second horizontal line. Tighten the hoop screw.

To embroider the remaining words, return to your PC and click on “new” (A).

Repeat the above programming steps (1-9).

The second and fifth words (“jus d’orange” and “pommes de terre”) need two hoopings each. Program the words in two parts and embroider. Re-hoop, continuing with the next part of the word on the same line as illustrated.

When all the words are embroidered, carefully remove any excess stabilizer and remove the embroidery unit.

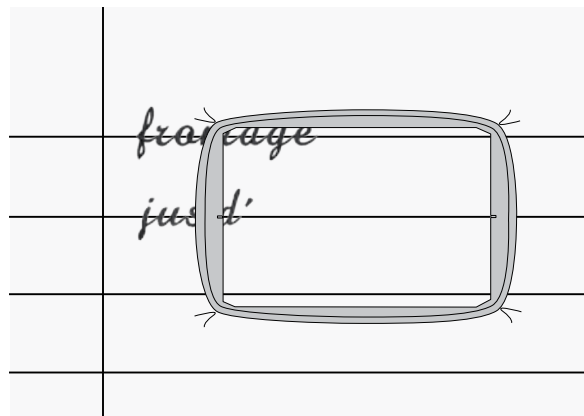
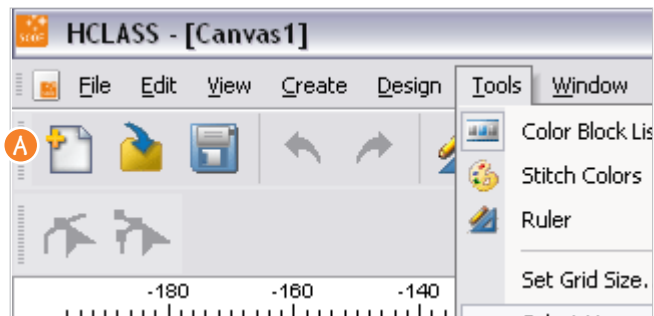

SEW

Remove the embroidery foot and attach the Utility Foot and shank. Thread your sewing machine with sewing thread on top and in the bobbin. Overcast or serge the raw edges of the canvas tote piece.

Fold the 4" x 36" (10 x 90 cm) strips in half right sides together. Sew the long sides together with a straight stitch using a 3/8" (1 cm) seam allowance. Trim the seam allowance. Turn right side out with the Fasturn. Edge stitch on both sides.

Pin and baste the handles to the outside of the bag 5 1/2" (14cm) from the side seams, align the raw edges. On the top of the bag, baste 2" (5cm) from the edge, catching the handles in the basting. Fold the top over twice towards the wrong side. Pull the handles back up towards the top of the bag. Sew the folded edge and the handles in place with a straight stitch.

Place the front and back pieces right sides together. Sew the bottom and side seams. Press seams open.

To make the 5 1/2" (14cm) wide base for the bottom of the bag, match the side seam to bottom seam and sew across the corner 2 3/4" (7 cm) from the tip as illustrated. Repeat for opposite side. Press.

Stitch the handles in place with a straight stitch creating an “X” as shown.

